



















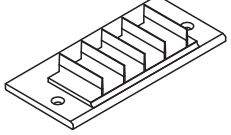



| ΣΧΕΔΙΟ DESIGN | ΚΩΔΙΚΟΣ CODE | ΠΕΡΙΓΡΑΦΗ DESCRIPTION | ΣΧΕΔΙΟ DESIGN | ΚΩΔΙΚΟΣ CODE | ΠΕΡΙΓΡΑΦΗ DESCRIPTION |
|---|-----------------|---|--|-----------------|---|
|  | 015000 | Λάστιχο τζαμιού σφήνα 1.5mm Glazing gasket 1.5mm <i>EPDM Μαύρο/Black</i> |  | 015001 | Λάστιχο τζαμιού σφήνα 2-3mm Glazing gasket 2-3mm <i>EPDM Μαύρο/Black</i> |
|  | 015002 | Λάστιχο τζαμιού σφήνα 3-4mm Glazing gasket 3-4mm <i>EPDM Μαύρο/Black</i> |  | 012003 | Περιμετρικό λάστιχο (φούσκα) Perimetric gasket <i>EPDM Μαύρο/Black</i> |
|  | 012005 | Περιμετρικό λάστιχο (διπλό νυχάκι) Perimetric gasket <i>EPDM Μαύρο/Black</i> |  | 019007 | Λάστιχο γάτζου Gasket for clip on hook <i>EPDM Μαύρο/Black</i> |
|  | 019001 | Λάστιχο για άνω οδηγό inox Gasket for the inox runner - upper part <i>EPDM Μαύρο/Black</i> |  | 019002 | Λάστιχο για κάθετο οδηγό inox Gasket for the inox runner - vertical part <i>EPDM Μαύρο/Black</i> |
|  | 019005 | Λάστιχο σίτας (6.3mm) Gasket for mosquito screen (6.3mm) <i>Μαύρο/Black - Λευκό/White</i> |  | 019006 | Λάστιχο σίτας (5.5mm) Gasket for mosquito screen (5.5mm) <i>Μαύρο/Black - Λευκό/White</i> |
|  | 014600 | Ελαστικός τάκος στεγάνωσης Sealing elastic gasket <i>Μαύρο/Black</i> | | | |

ΒΟΥΡΤΣΑΚΙΑ - BRUSHES

| ΣΧΕΔΙΟ DESIGN | ΚΩΔΙΚΟΣ CODE | ΠΕΡΙΓΡΑΦΗ DESCRIPTION |
|---|-----------------|--|
|  | 060000 | Βουρτσάκι 4mmx7mm Brush 4mmx7mm <i>Μαύρο-Γκρι/Black-Grey</i> |
|  | 061001 | Βουρτσάκι 7mmx6mm Brush 7mmx6mm <i>Λευκό-Μαύρο-Γκρι White-Black-Grey</i> |
|  | 061003 | Βουρτσάκι 7mmx8mm Brush 7mmx8mm <i>Λευκό-Μαύρο-Γκρι White-Black-Grey</i> |
|  | 061005 | Βουρτσάκι 7mmx12mm Brush 7mmx12mm <i>Λευκό-Μαύρο-Γκρι White-Black-Grey</i> |

| ΣΧΕΔΙΟ DESIGN | ΚΩΔΙΚΟΣ CODE | ΠΕΡΙΓΡΑΦΗ DESCRIPTION |
|---|-----------------|--|
|  | 061000 | Βουρτσάκι 7mmx5mm Brush 7mmx5mm <i>Λευκό-Μαύρο-Γκρι White-Black-Grey</i> |
|  | 061002 | Βουρτσάκι 7mmx7mm Brush 7mmx7mm <i>Λευκό-Μαύρο-Γκρι White-Black-Grey</i> |
|  | 061004 | Βουρτσάκι 7mmx10mm Brush 7mmx10mm <i>Λευκό-Μαύρο-Γκρι White-Black-Grey</i> |
|  | 062000 | Βουρτσάκι 8mmx18mm Brush 8mmx18mm <i>Λευκό-Μαύρο-Γκρι White-Black-Grey</i> |

| | | |
|---|---------------|--|
|  | 063000 | Βουρτσάκι με μεμβράνη 7mmx6mm Brush with membrane 7mmx6mm <i>Λευκό-Μαύρο-Γκρι White-Black-Grey</i> |
|  | 063002 | Βουρτσάκι με μεμβράνη 7mmx8mm Brush with membrane 7mmx8mm <i>Λευκό-Μαύρο-Γκρι White-Black-Grey</i> |

| | | |
|---|---------------|--|
|  | 063001 | Βουρτσάκι με μεμβράνη 7mmx7mm Brush with membrane 7mmx7mm <i>Λευκό-Μαύρο-Γκρι White-Black-Grey</i> |
|  | 063003 | Βουρτσάκι με μεμβράνη 7mmx10mm Brush with membrane 7mmx10mm <i>Λευκό-Μαύρο-Γκρι White-Black-Grey</i> |

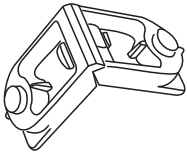
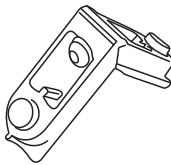
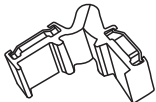
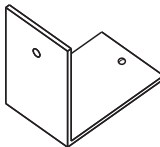
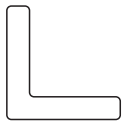
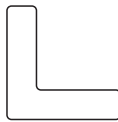

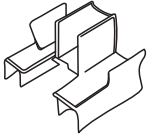
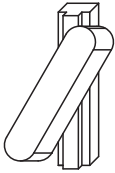
| ΣΧΕΔΙΟ DESIGN | ΚΩΔΙΚΟΣ CODE | ΠΕΡΙΓΡΑΦΗ DESCRIPTION | ΣΧΕΔΙΟ DESIGN | ΚΩΔΙΚΟΣ CODE | ΠΕΡΙΓΡΑΦΗ DESCRIPTION |
|--|-----------------|--|---|-----------------|--|
|  | 040003 | Γωνία σύνδεσης Corner cleat 28.4mm x 10.8mm |  | 040005 | Γωνία σύνδεσης Corner cleat 19mm x 11mm |
|  | 041001 | Γωνία σύνδεσης Corner cleat 12mm x 9.5mm |  | 042008 | Γωνία σύνδεσης για inox οδηγούς Corner cleat for inox runners 27.6mm x 2.8mm |
|  | 030000 | Γωνία επιπεδότητας Aligment corner (inox) 5mm x 1mm |  | 030002 | Γωνία επιπεδότητας Aligment corner (inox) 7mm x 1.5mm |

| ΣΧΕΔΙΟ DESIGN | ΚΩΔΙΚΟΣ CODE | ΠΕΡΙΓΡΑΦΗ DESCRIPTION |
|---|-----------------|---|
|  | 020600 | <p>Τάπα μπινί αντικρουστού Plastic cover for clip on central for opposite sashes</p> <p>PVC</p> |
|  | 023001 | <p>Τάπα οβαλίνας Plastic cover for oval profile</p> <p>PVC</p> |

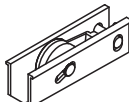
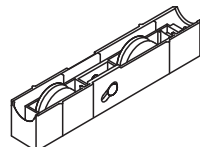
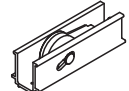
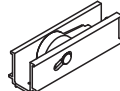
| ΣΧΕΔΙΟ DESIGN | ΚΩΔΙΚΟΣ CODE | ΠΕΡΙΓΡΑΦΗ DESCRIPTION |
|---|-----------------|--|
|  | 021000 | <p>Τάπα γάτζου PVC cover for clip on hook</p> <p>PVC</p> |

| ΣΧΕΔΙΟ DESIGN | ΚΩΔΙΚΟΣ CODE | ΠΕΡΙΓΡΑΦΗ DESCRIPTION | ΣΧΕΔΙΟ DESIGN | ΚΩΔΙΚΟΣ CODE | ΠΕΡΙΓΡΑΦΗ DESCRIPTION |
|---|-----------------|--|--|-----------------|---|
|  | 051000 | Ράουλο μονό φύλλου για inox οδηγούς Single sash roller for inox runners |  | 052001 | Ράουλο διπλό φύλλου για inox οδηγούς Double sash roller for inox runners |
|  | 051001 | Ράουλο σίτας για inox οδηγούς Single mosquito screen roller for inox runners |  | 051009 | Ράουλο στενής σίτας Mosquito screen roller |

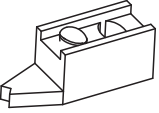
ΑΜΟΡΤΙΣΕΡ - AMORTISEUR
ΣΤΟΠΕΡ - STOPPER

| ΣΧΕΔΙΟ DESIGN | ΚΩΔΙΚΟΣ CODE | ΠΕΡΙΓΡΑΦΗ DESCRIPTION |
|---|-----------------|---|
|  | 080002 | Αμορτισέρ φύλλου για απλούς & inox οδηγούς Sash amortisseur for common & inox runners <i>Λευκό/White - Μαύρο/Black</i> |
|  | 080004 | Αμορτισέρ στένης σίτας για απλούς & inox οδηγούς Mosquito screen amortisseur for common & inox runners <i>Λευκό/White - Μαύρο/Black</i> |

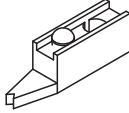
| ΣΧΕΔΙΟ DESIGN | ΚΩΔΙΚΟΣ CODE | ΠΕΡΙΓΡΑΦΗ DESCRIPTION |
|---|-----------------|---|
|  | 080006 | Αμορτισέρ σίτας για inox οδηγούς Mosquito screen amortisseur for inox runners <i>Λευκό/White - Μαύρο/Black</i> |

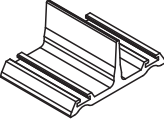
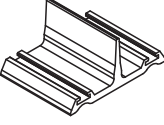
| | | |
|---|---------------|---|
|  | 090008 | Στόπερ - 28mm Stopper - 28mm <i>Λευκό/White</i> |
|  | 090010 | Στόπερ - 23mm Stopper - 23mm <i>Λευκό/White</i> |

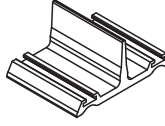
| | | |
|--|---------------|---|
|  | 090009 | Στόπερ - 12mm Stopper - 12mm <i>Λευκό/White</i> |
|--|---------------|---|

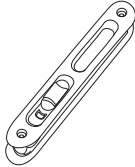
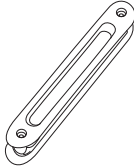
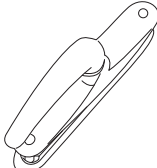
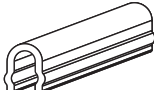
| ΣΧΕΔΙΟ DESIGN | ΚΩΔΙΚΟΣ CODE | ΠΕΡΙΓΡΑΦΗ DESCRIPTION | ΣΧΕΔΙΟ DESIGN | ΚΩΔΙΚΟΣ CODE | ΠΕΡΙΓΡΑΦΗ DESCRIPTION |
|---|-----------------|---|--|-----------------|---|
|  | 107810 | Χωνευτή κλειδαριά συρόμενου Fitted lock for sliding systems |  | 107842 | Χούφτα συρόμενου Fitted handle for sliding systems |
| | 107911 | Κιτ DSL με λευκές προσθήκες Kit DSL white pocket (7911) |  | 107910 | Σπανιολέτα συρόμενου Operating handle for sliding systems |
| | 107914 | Κιτ DSL με ΙΝΟΧ λευκές προσθήκες Kit dsl INOX with white pocket (7914) | | | |
|  | 990000 | Προφίλ inox (316-L) Inox profile (316-L) | | | |